



**om Elevator<sup>®</sup>**

# **ELEVATOR** *Solutions*

“**Style Performance,  
Durability, Comfort &  
Advanced Technology  
with Reliable Quality**”





## ABOUT US

**OM Elevators** is an ISO 9001:2015 Certified company founded in 2012 by Mr. Vimal Ladani & Mr Prashant Araniya who is a respected veteran in the field of elevators, envisaged and incorporated the company for the manufacturing and marketing of elevators. He has rich & deep experience in the key industry and trade experience combined with the proven ability to implement effective solutions.

The company has a clear focus on achieving and sustaining leadership in the domain of Lift & Elevators engineering & technology. The company incorporates proven logistics expertise and latest innovative designs, optimize and customize operations for maximum efficiency and over all cost savings, improved customer service. Reduced risk factor and lower capital expenditure.

# “ Why Choose Us

- ✔ We have been installing, Repairing and Maintaining lifts more than 10 Years.
- ✔ We have been recognized as the best company across Gujarat.
- ✔ We have wide network of installers and engineers across all over India.
- ✔ Our Engineers are highly qualified and skilled having good experience.

## VISION

We are a world leader in the manufacturing of lifts.  
We achieve constant growth and success by investing in innovation, infrastructure and our people.

## MISSION

As a global enterprise, we innovate, we invest in our people and we grow, aiming at exceptional customer experience through a personal approach.

## Our Products Range

- ✔ Passenger Elevator
- ✔ Machine Room-Less Elevator
- ✔ MR Elevator
- ✔ Hydraulic Elevator
- ✔ Capsule Elevator
- ✔ Hospital Elevator
- ✔ Frieght/Goods Elevator
- ✔ Automatic Doors
- ✔ Manual Doors
- ✔ Cabins Options
- ✔ Operating Panels & Displays
- ✔ Elevator machine
- ✔ Elevator Controller
- ✔ Auto Door Header
- ✔ Dust/Flame proof equipment

# Passenger & Home Elevator

## Capacity 04 to 15 Passenger

The design which brings convenience to extensive passengers which adopts all the measures which that aims at providing the passengers with the more secure and the more comfortable riding.

- ☑ Eye- catling display and door-opens button
- ☑ Highly Sensitive buttons
- ☑ Voice announcement (optional)
- ☑ Humane handrail (optional)



Om Passenger Elevator has flexible and diverse designs which can integrate in multiple buildings and home. It ca especially satisfy the contentious increasing requirements from medium and high rise constructions. It is a most ideal choice for the hotel, restaurant, office building, commercial and residential building, recreation canter, shopping center etc.

Load		Lift Well		Car Well		Entrance	Machine Room			Speed Up To 1 m/s.	
Person	Weight	Width	Depth	Width	Depth		Width	Depth	Height	Pit	O.H.
In Kg.		A	B	C	D	E	F	G	H		
4	272	1300	1300	1100	700	700	2600	3200	2500	1500	4800
5	340	1400	1300	1100	850	700	2600	3350	2500	1500	4800
6	408	1500	1500	1100	1000	700	2600	3500	2500	1500	4800
8	544	1800	1800	1350	1300	800	2850	3800	2500	1500	4800
10	680	2300	2100	2000	1300	800	3500	3800	2500	1500	4800
13	884	2600	2300	2000	1300	900	3500	3800	2500	1500	4800
15	1020	2700	2400	2000	1300	900	3500	3800	2500	1500	4800

# Passenger & Home Elevator



## Cab and shaft door with wall connection T1 Door sills

- ☑ **Shaft Door**  
Two Piece, central opening, sliding door, primed steel plate.
- ☑ **Accessories**  
Stainless steel with finishing grinding Door frame / wall connection Prime steel plate.
- ☑ **Cab Door**  
Two-piece, central opening, sliding door, stainless steel with finishing grinding.
- ☑ **Door Skills**  
Aluminum

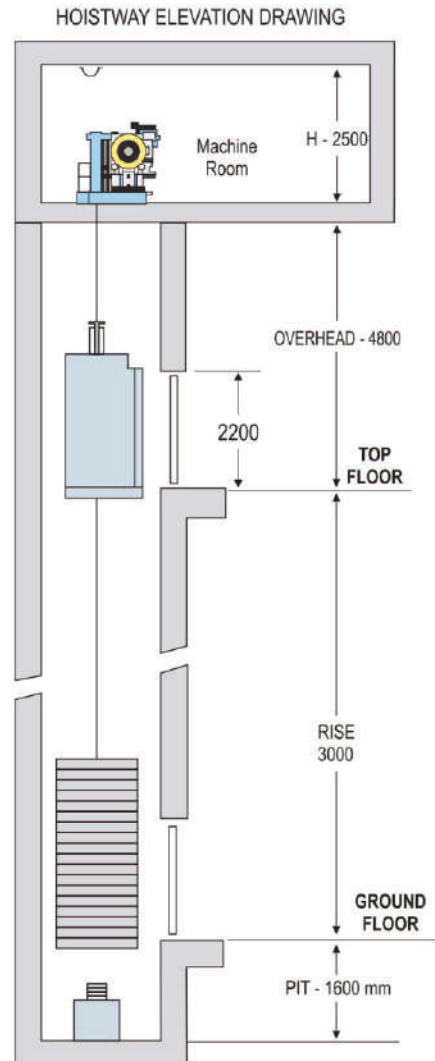
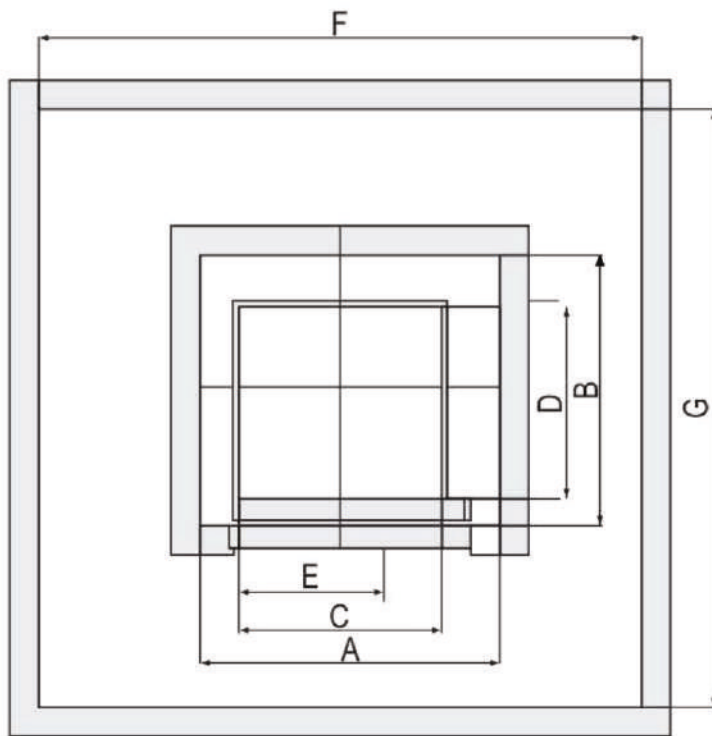

# Machine Roomless Elevator

## Capacity 03 to 20 Passengers

Machine Room-Less (MRL) Lifts are traction elevators that feature a compact motor drive mounted on the car itself. They don't require to build a separate elevator machine room.

MRL Lifts allow you architectural flexibility, but they also provide fast, powerful and energy-efficient transportation. Though traction lifts were originally limited to high-rises, the innovative MRL design has allowed engineers to adapt traction elevators for low-rise buildings and multi-storey Apartments

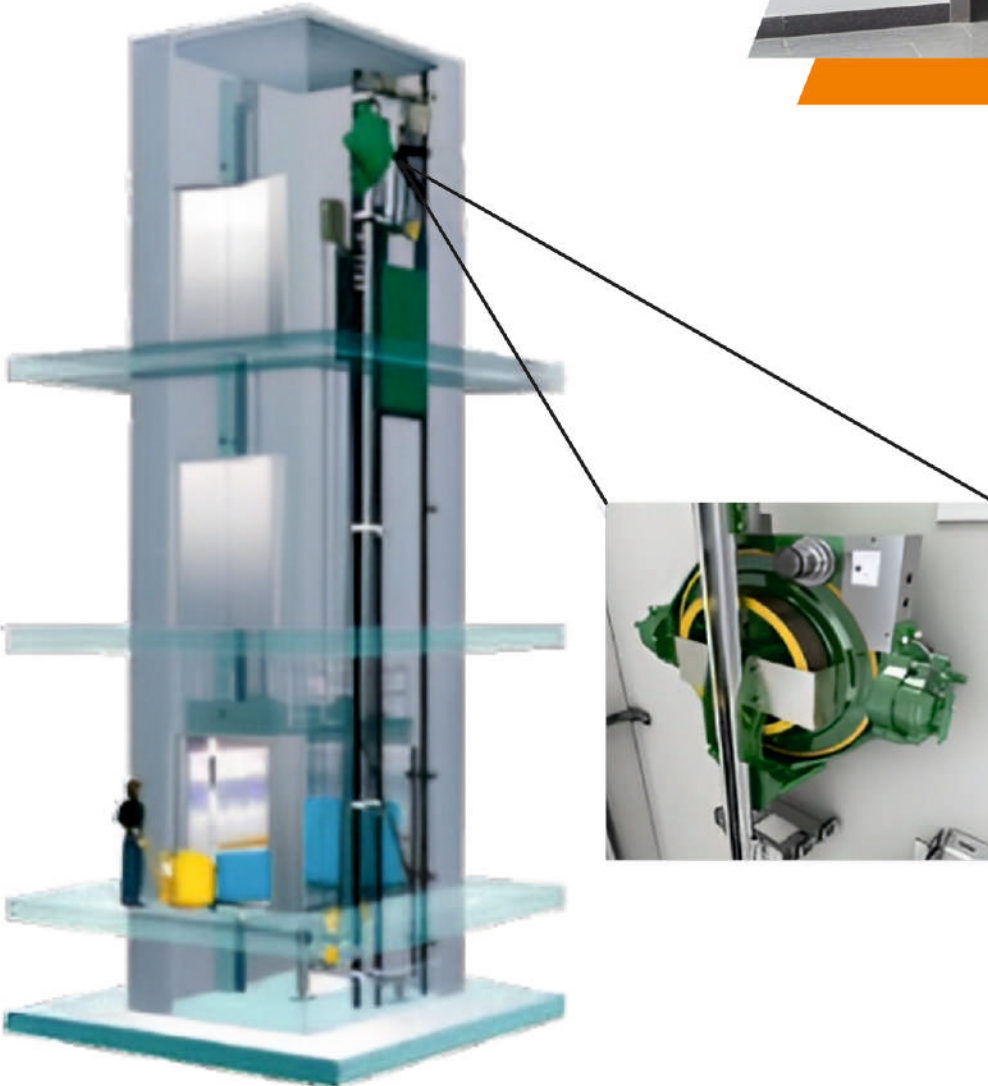

3 Nos.- Load Hook (3 Ton Capacity)  
Client Scope Refer Details  
in Inspection Window at Terrace Level

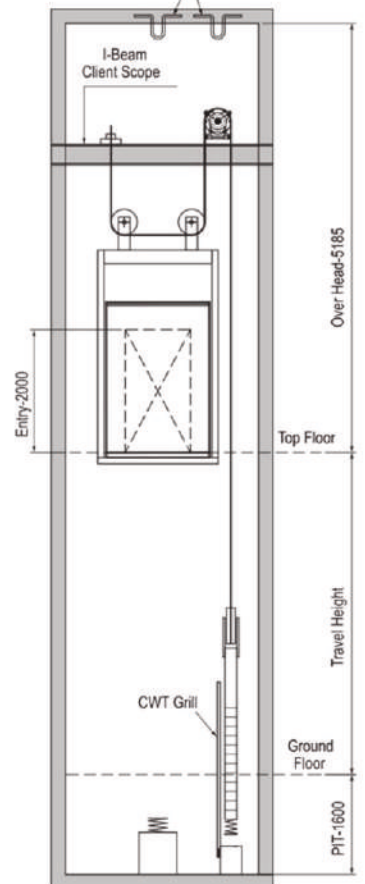

# Machine Roomless Elevator

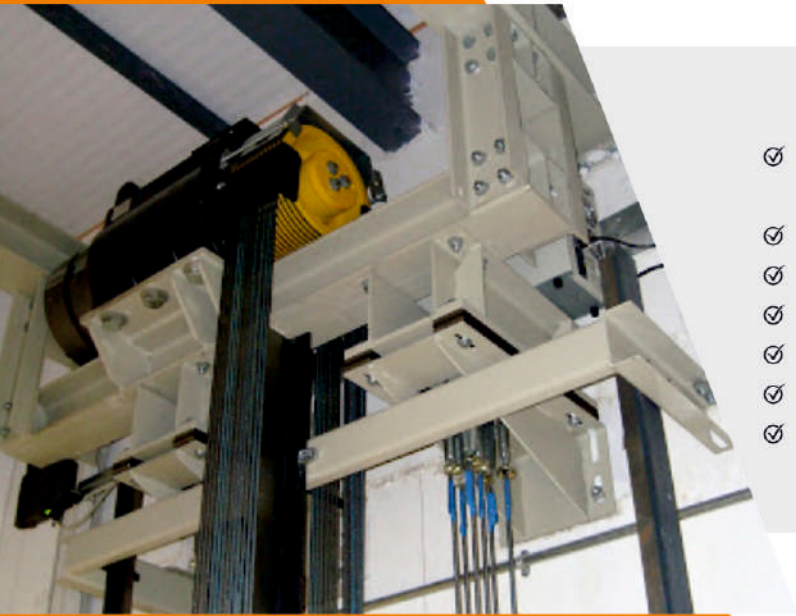

## Advantages of MRL Elevators

- ✓ Permanent Magnet Gearless Machine for smooth and quiet motion.
- ✓ 1 m/s to 1.6m/s speed range (180 starts per hour).
- ✓ 10 to 16 passengers load range (680 - 1088kg).
- ✓ Smooth ride, due to the first class roller shoe suspension.
- ✓ Versatile landing and car configurations.
- ✓ Earthquake-friendly jugged guiding.
- ✓ Totally integrated system for greater reliability.

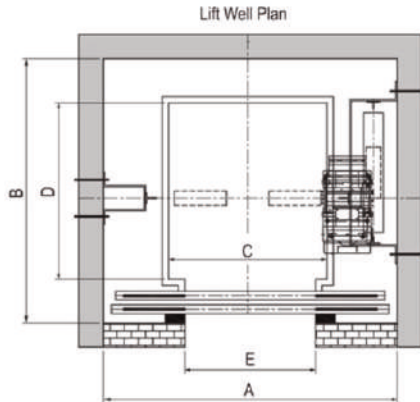
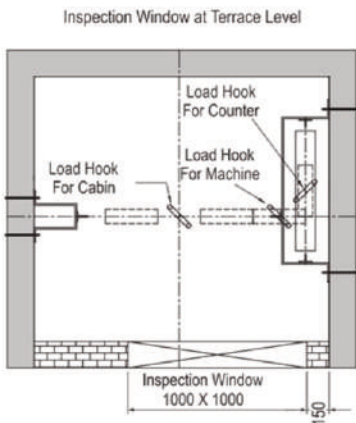

## Dimensional Details :

Machine Roomless Elevator

Capacity		Lift Well		Car Inside		Clear Entrance	Clear Entrance	
Person	KGS	C	D	A	B	E	F (Auto Door)	F (Manual Telescopic)
6	408	1800	1400	1200	900	700	780 / 2100	1450 / 2350
8	544	1900	1600	1300	1100	800	880 / 2100	1600 / 2350
10	680	1900	1800	1300	1300	800	880 / 2100	1600 / 2350
13	884	2200	1900	1600	1400	900	980 / 2100	1700 / 2350

# Machine Room Elevator

## Capacity 03 to 20 Passengers

It is a type of elevator in which the elevator drive is placed in a room built above the elevator shaft. It is not preferred in modern architectural projects in terms of aesthetics and increasing the economic value of the building. Engine room elevators have the disadvantage that they require an engine room tower above the shaft. In machine room elevators, geared (asynchronous) machine-motor group is generally used, but gearless motors are preferred.

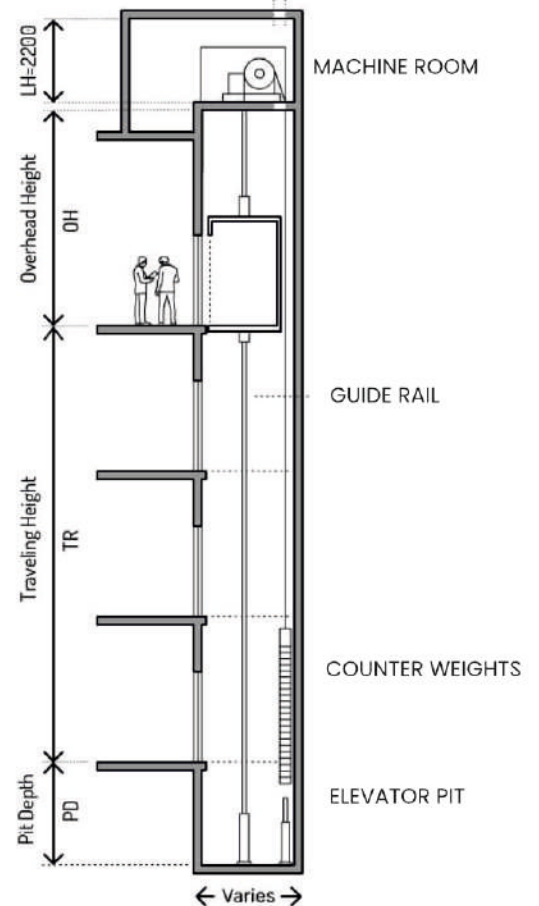

# Machine Room Elevator



## Advantages of MR Elevators

- ☑ Automatic Rescue Device (ARD) with Voice Enabled Emergency Backup System (VEEBS)
- ☑ Infra Red Full Length Doors Sensor With 154 Beams
- ☑ Motor Thermal Protection Function Etc.
- ☑ Wide Range Of Doors with Width and Height
- ☑ Cabin Fan and Light Shut Off and Automatic
- ☑ Overload Device With Voice Announcement
- ☑ Emergency break release and Manual Operation

## Optional Features :

- ☑ Duplex Collective – Selective, Triplex Functioning Available.
- ☑ Selectable Service Floors Function
- ☑ 2 Hours Fire Rated Doors approved By CBRI-IIT, Roorkey
- ☑ Different type of Flooring (Vitrified tiles / Wooden / PVC Flooring)
- ☑ Small Vision Glass Doors
- ☑ Push & Touch Panel COP / LOP
- ☑ Vast range of designer ceilings with laser cut designs, chandeliers and other lighting options.

HOISTWAY MACHINE ROOM  
PLAN FOR AUTO DOOR

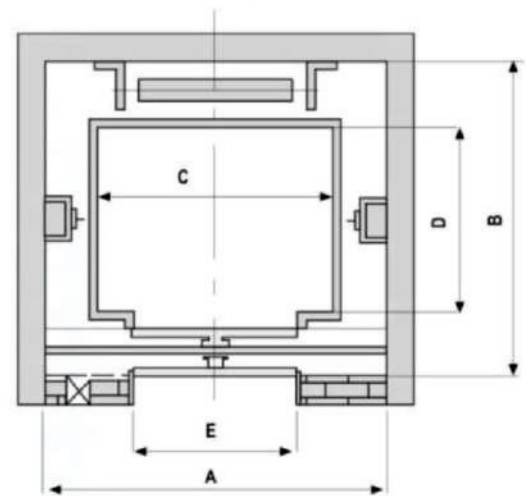

## Dimensional Details :

Machine Rooml Elevator

Capacity		Lift Well		Car Inside		Clear Entrance	Machine Room		
Person	KGS	C	D	A	B	E	Width	Depth	Height
6	408	1900	1650	1100	1000	800	3000	3500	2500
8	544	1900	1900	1300	1100	800	3200	3500	2500
10	680	2100	2000	1350	1300	900	3500	4000	2500
13	884	2500	1900	2000	1100	1000	4000	4200	2500

## Hydraulic Elevator (For Low Rise)

Looking for a low-maintenance elevator Hydraulic lifts provide the advantages of being relatively inexpensive, safe and easy to maintain. They're very convenient and cost-effective solution for low-rise buildings with low traffic.

Hydraulic elevators have been rated the safest option for home elevators. They boast superb user friendliness and easy access machine room located at the basement. Once they are put in place, hydraulic elevators provide the smoothest rides possible.

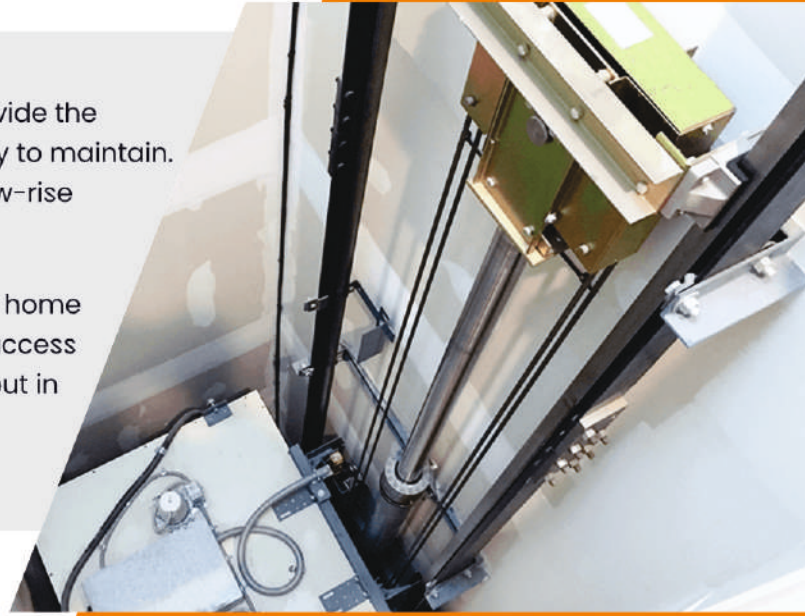

# Hydraulic Elevator (For Low Rise)



## Hydraulic Elevator Benefits

- ✓ Safe, secure and powerful vertical transportation
- ✓ Low installation and maintenance cost compared to a traction lift
- ✓ A longer operating lifetime
- ✓ Comfort and low noise
- ✓ Simple & fast installation
- ✓ Single-time phase-3 power (for ascending) & phase-1 (for descending)
- ✓ Low unit cost, even minimal inventory

## Type of Suspensions

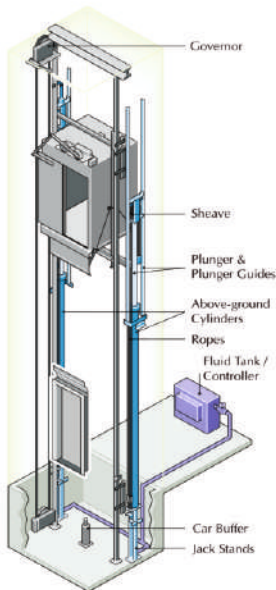

### Rope Type

Side indirect acting suspension with wire ropes with one piston for regular loads and long travels.

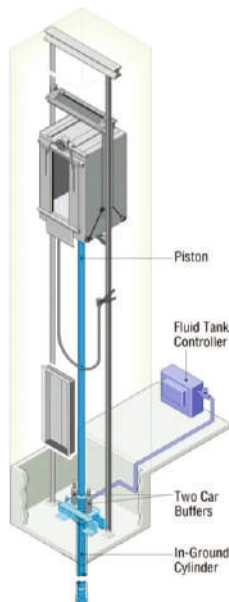

### Hole Type

Direct suspension. The simplest solution for any load with a simple or split piston

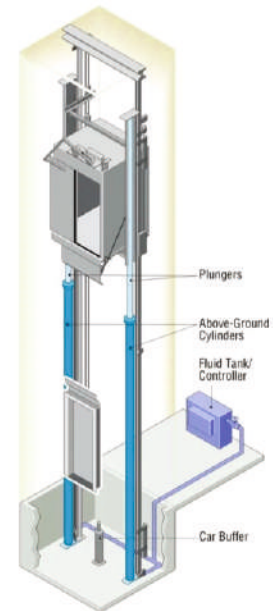

### Hole less Type

Side direct suspension with two simple piston for large loads and short travels. (max. Travel 4MT.)

# Capsule / Panoramic Elevator

## Capacity 08 to 20 Passengers

Glass capsule elevators give an upscale, attractive feel to offices, shopping malls, multiplexes and other prestigious buildings. These lifts owe their stunning looks to the large glass viewing panels which provide entertaining ride to passengers.

Capsule elevators work just as well as small person lifts for private homes as they do in large office and commercial buildings. Installation on the exterior face of the building or in the lobby will totally change the look of a building and of course, they incorporate the technology.



## Features

- ✓ Glass/Stainless steel/designer stainless steel / gold finish stainless steel.
- ✓ AC VVVF drive for smooth operations and variable speeds.
- ✓ Over load indications and floor announcement system.
- ✓ Infrared curtain for door safety.



Option A

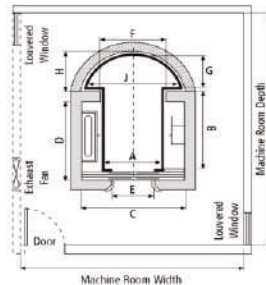

Option B

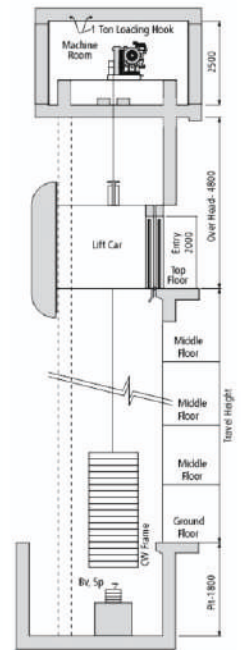
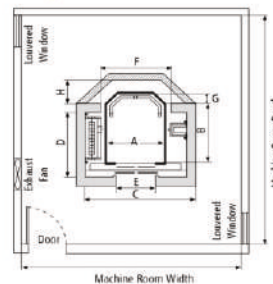

Option - A

Person	Load Kgs.	Car Inside				Lift Well				Entrance E
		A	B	J	G	C	D	F	H	
10	680	1100	1300	1400	650	2200	1325	1330	1100	800
13	884	1200	1400	1550	700	2400	1425	1430	1100	900
16	1088	1300	1500	1700	750	2800	1530	1530	1200	1000

Option - B

Person	Load Kgs.	Car Inside			Lift Well				Entrance E
		A	B	G	C	D	F	H	
10	680	1250	1300	250	2200	1450	1480	580	800
13	884	1400	1400	300	2400	1550	1630	650	900
16	1088	1550	1500	350	2800	1780	1650	790	1000

# Hospital Elevator



## Capacity 15 to 26 Passengers

Hospital Elevators provide easy transportation of patients and bulky medical equipment such as gurneys, stretchers and wheel chairs. These lifts feature sophisticated looks and operated smoothly.

Hospital Elevators are available in a wide variety, capable of carrying between 15 to 26 passengers at a time. These elevators usually feature center-opening, telescopic power-operated doors and easy to use for people.

## How We Work

- ✓ Auto leveling to ensure smooth movement of passengers
- ✓ Large opening options for easy access
- ✓ Rescue system for power cuts
- ✓ Non stop function for emergencies
- ✓ Designs to add brightness in the hospital

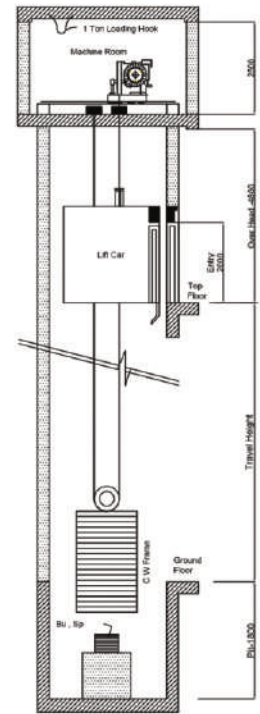

(section :X-X) Lift Well

### Automatic Center Opening Door Lifts

Persinal	Capacity	Car-W	Car-D	Shaft-W	Car-D	Car-D
	KG	(A)	(B)	(C)	(D)	(E)
15	1020	1900	3000	1000	2400	800
20	1360	2300	3000	1300	2400	900
26	1768	2600	3000	1600	2400	1000

### Automatic Telescopic Door Lifts

Persinal	Capacity	Car-W	Car-D	Shaft-W	Car-D	Car-D
	KG	(A)	(B)	(C)	(D)	(E)
15	1020	1700	3000	1000	2400	800
20	1360	1360	3000	1300	2400	900
26	1768	2100	3000	1600	2400	1000

# Freight/ Goods Elevator

## Capacity 500 to 5000 kg. Load

A freight elevator is used to carry goods only, through some do both to allow operators and those loading goods along for the ride.

Freight elevators are typically larger and capable of carrying heavier loads than a passenger elevator, generally from 2,300 to 4,500 kg. freight elevators have manually operated doors and often boast rugged interior finishes to prevent damage while loading and unloading. Although hydraulic freight elevators exist, electric elevators are more energy-efficient for the work of freight lifting.

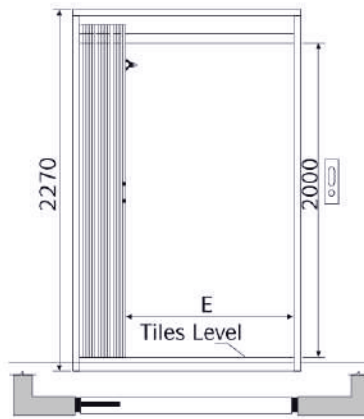
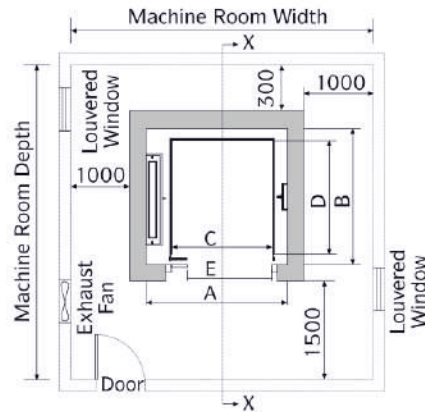
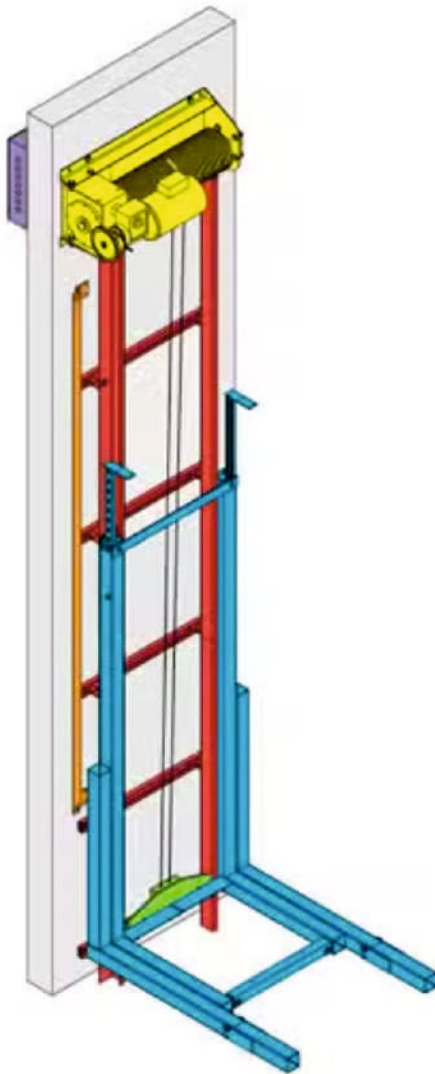

Collapsible Door Landing

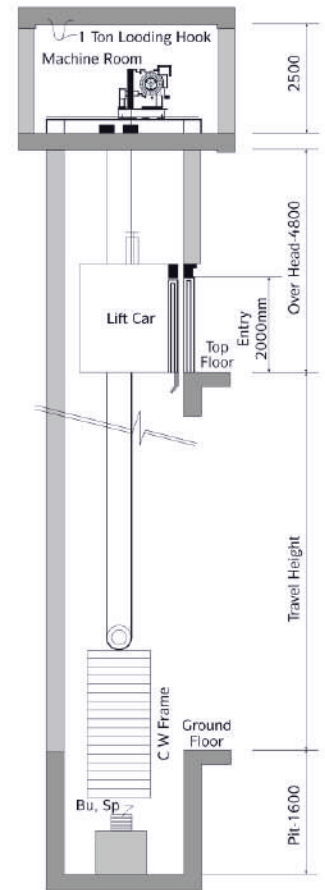

(section : X-X) Lift Well

# Freight/ Goods Elevator



## Advantages of Freight/ Goods Elevator

- ✓ Saves installation space, as no ramp is required.
- ✓ Automatic travel for lifts with 2 stops for maximum comfort.
- ✓ Fast and comfortable transport.
- ✓ High safety for persons and cars.
- ✓ Low Maintenance Durable design ensures minimal upkeep.
- ✓ Allows easy and efficient car movement in tight spaces.



## Dimensional Details :

Machine Roomless Elevator

Capacity	Shaft-W	Shaft-D	Car-W	Car-W	Entrance	Load	Speed	PIT	Over
KG	C	D	A	B	E	KG	MPS	Depth	Head
500	1900	1500	1100	1200	900	500	0.25		
1000	2300	2100	1400	1800	1150	-	-	1600	4800
1500	2600	2300	1700	2000	1400	300	1		
2000	2600	2800	1700	2500	1400	400			
3000	2900	3300	2000	3000	1700	-	0.25	2200	7400
4000	3400	3400	2500	3000	1900	5000			
5000	3500	4300	2500	3600	1900				

## Automatic Doors



The stylish way to  
**Brand Your  
Elevator**

The automatic doors at grocery stores and office buildings mainly exist for convenience. The automatic doors in an elevator, on the other hand, are absolutely essential - they keep people from falling down an open shaft.

Elevators use two different sets of doors: doors on the cars and doors opening into the elevator shaft. The doors on the cars are operated by an electric motor, which in turn is operated by the elevator computer.

### Advantages of Automatic Doors

- ✓ Safety : Prevents collisions, shatterproof glass, emergency fail-safe.
- ✓ Hygiene : Touchless entry reduces germ spread.
- ✓ Convenience : Easy access for all, smooth and quiet operation.
- ✓ Energy Savings : Minimizes heat loss, improves efficiency.
- ✓ Improved Entrance : Enhances aesthetics, attracts visitors.

# Automatic Doors



MS Powder Coated Center Opening Auto Door



MS Powder Coated Telescopic Auto Door



Stainless Steel Hairline Finish Auto Door



Telescopic Auto Door (Small Vision)



Center Opening Auto Door (Big Vision)



Center Opening (Four Panel) Auto Door

## Manual Doors



The stylish way to  
**Brand Your  
Elevator**

Elevators use two different sets of doors on the cars and doors opening into the elevator shaft. In a relatively short period of time, elevators have become essential to urban life. As people continue to erect monumental skyscrapers and make small buildings handicap-accessible, elevators will become an even more pervasive element in society. It is truly one of the most important - and useful - machines of the modern era.

### Advantages of Manual Doors

- ✓ Cost-Effectiveness Affordable installation and low maintenance.
- ✓ Simplicity & Reliability Fewer components, reducing malfunctions.
- ✓ Customization Variety of designs, materials, and finishes.
- ✓ Ease of Use Suitable for homes, commercial, and industrial spaces.
- ✓ Safety Features Equipped with interlocks and sensors.
- ✓ Aesthetics Blends with traditional or modern styles.

# Manual Doors



SS Collapsible Door

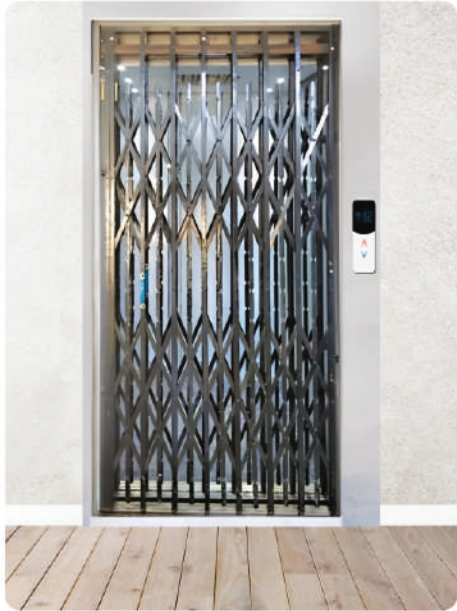

MS Collapsible Door



Imperforated Door



S.S. Telescopic Big Vision



M.S. Telescopic Door



M.S. Swing Door Big Vision

# Cabin Options



OM Elevator is India's leading elevator cabin manufacturer. With a wealth of experience and expertise in the industry, OM Elevator has established itself as a trusted name in elevator cabin manufacturing. We combine cutting edge technology and innovative design to create high quality, durable, and aesthetically pleasing elevator cabins. Our state of the art facilities and skilled workforce enable us to meet the diverse needs and specifications of our clients. Get in touch with us to get the best variety of elevator cabins for your customers.

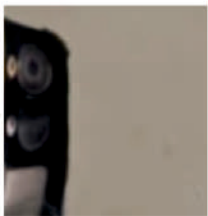

SS MIRROR



SS MATT



SS DESIGN

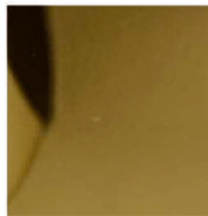

GOLD MIRROR



GOLD HAIRLINE



GOLD BEADBLAST

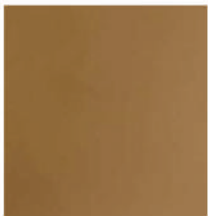

ROSEGOLD MIRROR



ROSEGOLD HAIRLINE

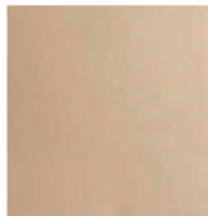

ROSEGOLD BEADBLAST



BLACK MIRROR

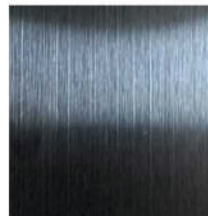

BLACK HAIRLINE



BLACK BEADBLAST

# Cabin Options



M.S. Powder Coated Car



SS Hairline & Mirror Finish Car



S.S. Design Finish Car



S.S. Rose Gold Car



SS Gold Mirror Finish Car



3D View Cabin Elevator

# Operating Panels & Displays



Simplicity. User-friendliness. We install control panels that show passengers your value, their time and safety - by getting them where they need to go, effortlessly.

### Monochrome Liquid Crystal Display (LCD)

This display is installed in the Car Operating Panel and Hall Position Indicators in place of the normal dot matrix display. It provides a monochrome graphical representation of lift position, directional arrows, date, time and messages

### Full Colour Liquid Display (LCD)

This full colour display is a high end, sophisticated display crystal system customized to show different effects like three dimensional arrows, floor legends, floor directories, analog clock face, digital clock, date, time and messages. It is installed in the Car Operating panel and Hall Position Indicators in place of the normal dot matrix display.

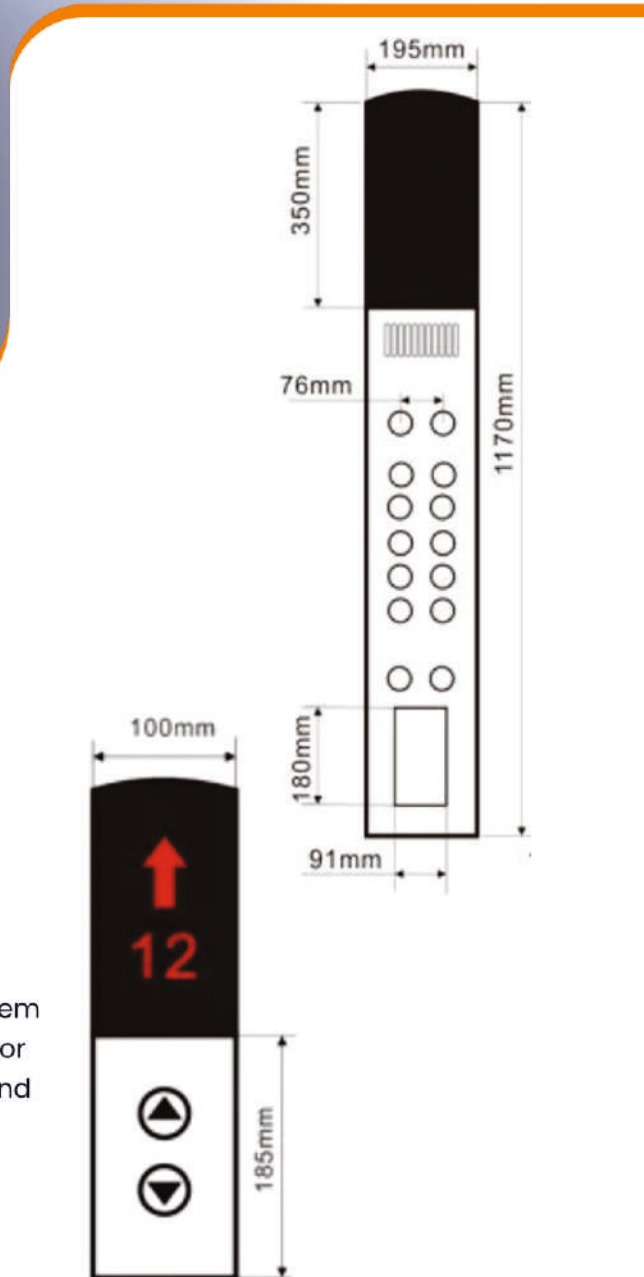

# COP/LOP & Buttons



OM - COP-LOP - 05



OM - COP-LOP - 06



OM - COP-LOP - 07  
Sami Touch

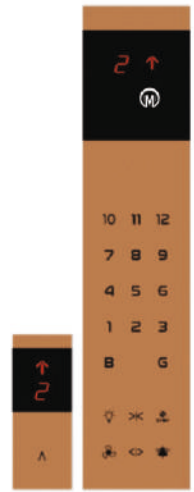

OM - COP-LOP - 08  
Full Touch



RFID Card System



Finger Print System



OM-E5



OM-ER



OM-31



OM-32



OM-33



OM-41



OM-52



OM-51



OM-83



OM-84



OM-22



OM-23



OM-11



OM-71

# Elevator Machine



Powering Smooth,  
Safe Lifts every Floor,  
Every Time.



Cauldron Geared Machine



High Speed Traction M/c.



Elevator Drum Machine



Single Phase Gearless M/c.



MRL Gearless M/c.



Over Speed Governor

# Elevator Controller

Smart Control For Smooth, Safe, And Efficient Rides



Close Loop (Integrated) Panel



Hydraulic Control Panel



Automatic Rescue Device (ARD)



Microprocessor Panel

# Auto Door Header

## Elevator Door Operator

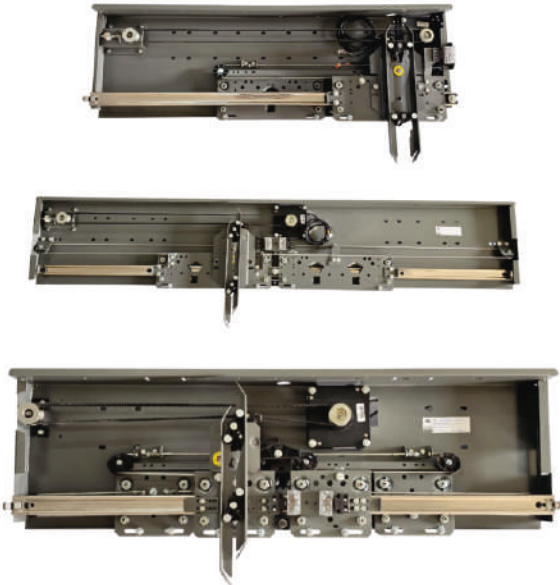

VVVF door operators controlled by the brand inverter

Door opening way	Center opening
Door opening Width	600 - 1200 mm
Height	2000 or 2100 mm

We can supply the door panels and still along with the door operator

Clear Opening in mm	Min. Req. shaft Width In mm	Car operating / Landing Mechanism length & Still length In mm
650	1350	1300
700	1455	1400
800	1655	1600
900	1855	1800
1000	2055	2000
1100	2255	2200
1200	2455	2400

Center Opening - 650 - 1200 mm standard Poors (Without runby), consider frame size 60mm-120mm.

Landing door match for the door operator

Door opening way	Side opening
Door opening Width	600 - 1200 mm
Height	2000 or 2100 mm

We can supply the door panels, still & door frame along with the landing door as requested

Clear Opening in mm	Min. Req. shaft Width In mm	Landing Mechanism length & Still length In mm	In mm car Operator length & still Length in mm
700	1168	1050	1090
800	1318	1200	1240
900	1468	1350	1390
1000	1618	1500	1540
1100	1768	1650	1690
1200	1918	1800	1840

## Elevator Landing Door

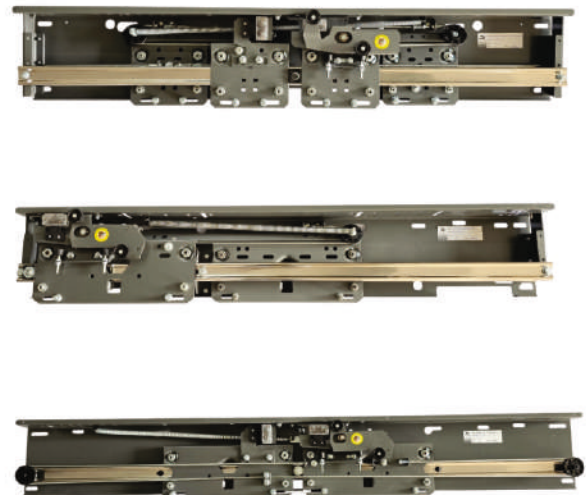

Side Opening - 650 - 1200 mm standard Poors (Without runby),

Note : In case of run by doors + 20mm Consider frame width is 90mm (for Telescopic)

# We Are Associated With



**FORM-B  
(ANNEXURE-III)  
GUJARAT STATE**

**Certificate of Authorization for Erection and Maintenance of Lifts.**

(This Certificate is to be renewed every three years and must be returned to the Chief Electrical Inspector at the appropriate time)

**Authorization No. GCZEM/126**

**Shri/Messrs**  
**OM ELEVATOR,**  
 103/A, 4, KRISHNA APARTMENTS, DUMKESH DHAM SOC., N.R. BACHRANWAD,  
 TQ. THAKKARBANAGAR, AHMEDABAD, GUJARAT, 380015, INDIA

**is/are hereby authorized to carry out Erection and Maintenance of Lifts within the state of Gujarat. This certificate of authorization is issued in compliance with the conditions set on Pedigree No. 042**

The day of Wednesday, May 14, 2025

Authorization valid upto the date	Title of the Chief Electrical Inspector
07/02/2025 to 06/02/2028	

Chief Electrical Inspector  
Gujarat State  
Gandhinagar

**GOVERNMENT OF GUJARAT**

**TRADE MARKS REGISTRY**

**TRADE MARKS ACT, 1999**

**Certificate of Registration of Trade Mark, Section 21 (2), Rule 59 (1)**

**Trade Mark No. 483420**

**Class No. 483420**

**Registration Date: 01/09/2020**

**Registration No. 2349**

**OM ELEVATOR**

**14<sup>th</sup> day of August, 2022**

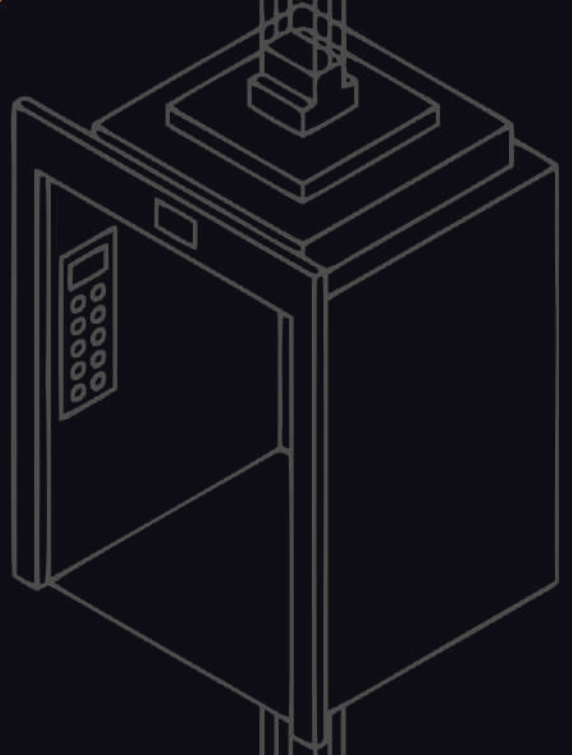

**om Elevator<sup>®</sup>**

+91 94297 79264 | +91 79904 49685

info@omelevator.in

www.omelevator.in

G/CZ/EML/126

GST No.: 24AAGFO6715LIZ1

A - 30, Patanjali Society, Part D, Ratan Park,  
B/H Bhumpark, Khodiyarnagar Road, Nikol,  
Ahmedabad, Gujarat - 382350.

QR CODE SCAN  
FOR WEBSITE

